

High quality

Using the technology Noritsu has developed over the years as a leader in silver halide printing, the QSS Green will blaze the trail in the new age of value-added digital prints.

High quality & High resolution

Beautiful sharp prints with multiple dot gradation dye ink system

The QSS Green uses a high-grade dye ink system that accurately portrays fine details due to its multiple dot gradation technology. The high quality ink, combined with the excellent absorbing quality of the paper, enables the QSS Green to produce outstanding print quality.

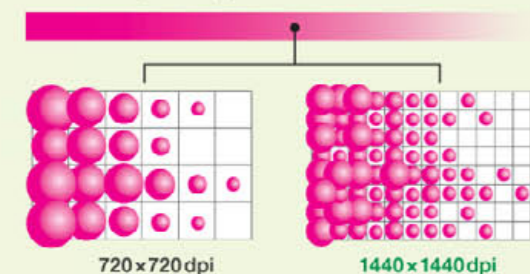

Two profiles to choose from

There are two profiles available as a standard feature for the QSS Green – One that emulates the look of silver halide prints, and one that uses the full inkjet gamut to produce more vivid colors. The profile can be easily changed anytime to meet individual needs.



Silver halide profile

Inkjet profile

High grade ink that produces long lasting colors

Prints made with conventional dye ink tend to fade quickly. However, the ink used in the QSS Green has an improved molecular structure so it is able to withstand light and ozone. This is why QSS Green prints boast excellent lightfastness and long lasting colors.

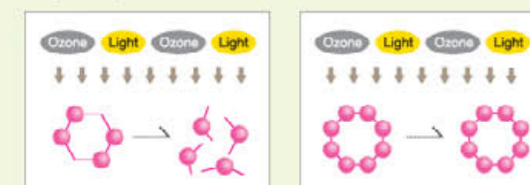

Molecular structure of convention dye ink
Parts of the molecular structure are weak. Results in deterioration and fading.

Molecular structure of QSS Green dye ink
The dye ink used in the QSS Green has been improved to withstand deterioration, ensuring your prints will be enjoyed for generations to come.

The QSS Green can make impressive 1440x1440dpi high-resolution prints

1440x1440dpi high resolution prints are less grainy and have smoother gradations than standard prints. Furthermore, this improvement in terms of graininess also has the effect of producing a better portrayal of contrast, texture and depth.



720x720 dpi

1440x1440 dpi

You can register different resolutions (the standard 720x720dpi or the high resolution 1440x1440) in different print channels in the EZ Controller. This enables you to easily change the resolution by simply changing print channels.

Raw file printing

High quality prints from raw image files



Adobe's DNG conversion technology is incorporated into the EZ Controller along with Noritsu's AccuSmart image processing technology. This means you can easily make high quality prints from raw image files without using separate raw file conversion software.

JPEG data



A large portion of the pixel data in the original JPEG image has highlight areas that are too light. When the image is corrected, the overall light in the image is reduced, but the pixels representing the highlight areas that were too light are unsalvageable.

Raw data



All gradations are used, producing an image that is balanced well. There are very few pixels with shadows that are too dark and highlights that are too light.

EZ Controller (Selling separately)

Optimize the image with EZ Controller

In addition to serving the important role of system operation software, EZ Controller also has a wealth of advanced image correction functions to correct sharpness, contrast, noise, backlight, red-eye, and under/over exposure, etc.



Specifications					
Printing system	Piezoelectric Inkjet system				
Print resolution	720x720 dpi 1440x1440 dpi				
Print size	Roll paper	Paper widths: 102, 127, 152, 203, 254 mm (4", 5", 6", 8", 10") Minimum Paper advance length: 88.9 mm (3.5") Maximum Paper advance length: 1757.7 mm (69.2")			
	Sheet paper	Paper widths: 102 mm (4") to 254 mm (10") Paper advance lengths: 178 mm (7") to 620 mm (24.4")			
Maximum print size	Roll paper: 254 x 1757.7 mm (10" x 69.2") Sheet paper: 254 x 620 mm (10" x 24.4")				
Paper types*1	Roll paper	Noritsu proprietary inkjet photo paper (Glossy/Semi-glossy) Paper widths: 102, 127, 152, 203, 254 mm (4", 5", 6", 8", 10") Paper roll length: 100 m (328 feet)			
		Print size	Double-sided sheet paper (Thin, Semi-glossy, HG)	Double-sided sheet paper (Thick, Semi-glossy, HG)	Double-sided sheet paper (Thick, Folded, Semi-glossy, HG)
	102 x 213 mm (4"x8.4")		Supported		
	203 x 213 mm (8"x8.4")	Supported			
	254 x 213 mm (10"x8.4")	Supported			
	254 x 188 mm (10"x7.4")			Supported	
	210 x 307 mm (8.3"x12.1")	Supported	Supported		
216 x 289 mm (8.5"x11.4")	Supported	Supported			
254 x 442 mm (10"x17.4")				Supported	
254 x 620 mm (10"x24.4")				Supported	
Ink	4 colors of dye ink: Y (Yellow), M (Magenta), C (Cyan), BK (Black) Volume: 500 ml per color				
Dimensions	See "External view" below				
Weight	Printer with the 8-order print sorter unit: Approx. 180.6 kg (398.2 lbs) (excluding options, paper and ink cartridges)				
Power specifications	AC 100-120V / 200-240V 1P2W				
Rated power capacity	1,000 VA or less				

*1 Paper types are subject to change without notice.

Repeat Printing Capacity (prints/hr)			
Print size (Width x Paper advance length)	Paper	Print resolution : 720 x 720dpi Prints/hour (Approx.)	Print resolution : 1440 x 1440dpi Prints/hour (Approx.)
127 x 89 mm (5" x 3.5")	Roll	750	260
102 x 152 mm (4" x 6")		510	169
152 x 102 mm (6" x 4")		650	213
203 x 254 mm (8" x 10")		250	78
254 x 203 mm (10" x 8")		280	86
254 x 305 mm (10" x 12")		195	58
203 x 203 mm (8" x 8")	Double-sided sheet paper	67	27
254 x 203 mm (10" x 8")		64	25
210 x 297 mm (8.3" x 11.7")		80	22

External view < Unit: mm (inches) >

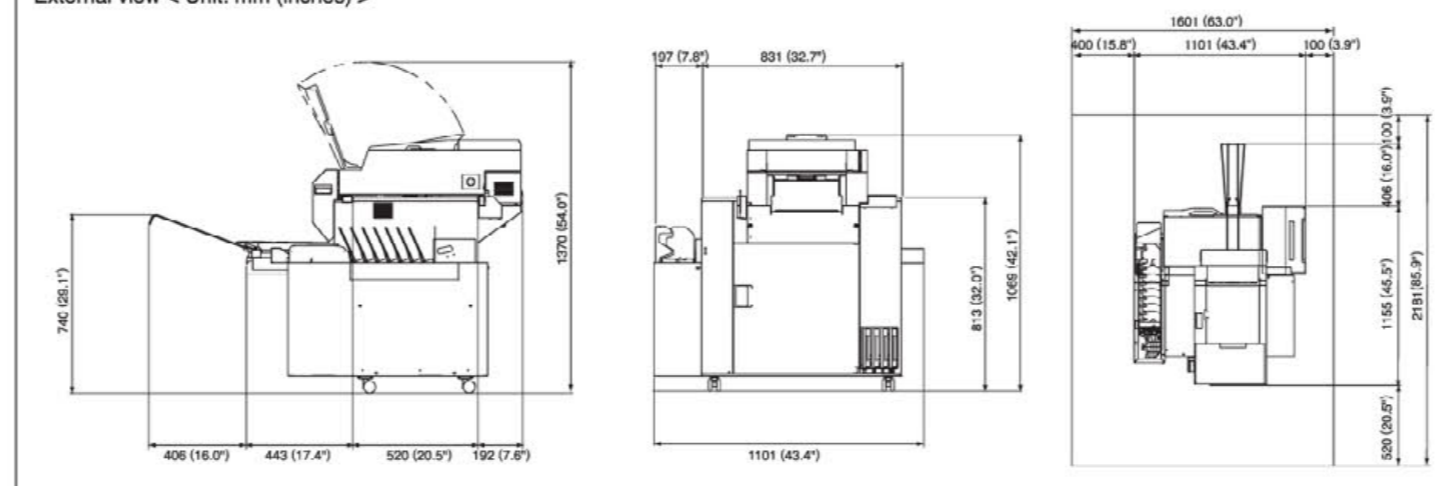

NK Works Co., Ltd.

The specifications, information, and appearance of the machine herein are subject to change without notice.

Our products have been manufactured under an ISO 9001-certified quality assurance system.

570-1 UMEHARA, WAKAYAMA SHI, 640-8550, JAPAN PHONE: (81)73-454-0345 FACSIMILE: (81)73-454-0301 http://www.noritsu.co.jp	COUNTRY	OFFICE	PHONE NO.	COUNTRY	OFFICE	PHONE NO.
	Australia	Noritsu Koki Australia Pty. Ltd.	(61) 2-9317-2141	Mexico	Noritsu Mexico S.A. De C.V.	(52) 55-2626-6710
	Brazil	Noritsu Do Brasil Ltda.	(55) 11-3779-0606	The Philippines	Noritsu Philippines, Inc.	(63) 2-812-8443
	Canada	Noritsu Canada Ltd.	(1) 905-567-8982	South Korea	Noritsu Korea Ltd.	(82) 2-509-2701
	China	Noritsu (Shanghai) P. E. M. Co., Ltd.	(86) 21-5046-3997	Singapore	Noritsu Singapore Pte. Ltd.	(65) 6778-8333
	Hong Kong	Noritsu (Far East) Ltd.	(852) 2873-4768	Taiwan	Noritsu Taiwan Co., Ltd.	(886) 2-2506-1908
	India	Noritsu India Private Ltd.	(91) 11-45757375	U. A. E.	Noritsu Near East Branch	(971) 4-8837556
	Malaysia	Noritsu Koki Malaysia Sdn. Bhd.	(60) 3-78762733	U. S. A.	Noritsu America Corporation	(1) 714-521-9040

NORITSU is a trademark of Noritsu Koki Co., Ltd.
QSS & AccuSmart are trademarks of NK Works Co., Ltd.
All other product and company names herein may be trademarks of their respective owners.



A new page in the QSS story



A new product is born in the QSS line

A dry printer has been added to the popular QSS minilab series, giving you another great product to choose from. In addition to having all the fabulous features that made the QSS brand so popular with silver halide printer users, the QSS Green meets the environmental needs and is set to become the new de-facto standard model for photo businesses. This new breed of QSS is poised to rewrite the history of photo printing.



New technological development

An adjustable platen gap to support a variety of papers

Platen gap is the gap between the print head and the paper. We have made the platen gap adjustable in the QSS Green. This enables it to process normal paper, cast coat paper and many other kinds of paper on the market.

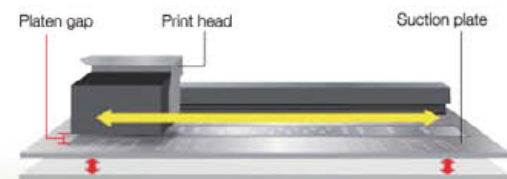

Enhanced value

With the QSS Green's wide variety of print services, you can provide new ways for people to enjoy their photos.

The adjustable platen gap enable you to choose a variety of papers

The fact that the platen gap is adjustable provides a big advantage because it enables the support of a wide variety of papers. Having more papers to choose from increases the variety of value-added products you can offer. With the ability to offer duplex prints and single-sided prints on a variety of different types of paper enables you to provide photo books and many other unique value-added products.

Metallic prints

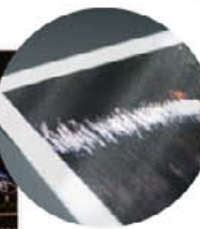

Metallic finish gives your prints a unique attractive appeal

Sticker prints

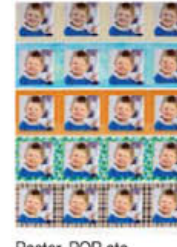

Poster, POP etc.

Duplex prints



Photo books



Greeting cards



Photo calendars

Enlargements/Panoramas

The QSS Green can make enlargements in sizes of 10"x12", 10"x14" and many other sizes, including panorama prints all the way up to 10"x69". This enables you to provide custom products such as poster prints, locker prints, and just about any custom print size you can think of.



254x457mm (10"x18")



Maximum print size
254×1757.7mm
(10"x69.2")



Panorama print

Enhanced productivity

Loaded with advantages such as speedy printing and reduced labor/maintenance, the QSS Green has what today's photo retailers need.

High capacity enabling a steady turnover

Print capacity is the key to maintaining smooth and steady profits. The QSS Green enables you to quickly fulfill urgent orders of any size without sacrificing its top-level print quality.

6"x4" (152x102mm) approx. **650** prints/hour

10"x8" (254x203mm) approx. **280** prints/hour

10"x12" (254x305mm) approx. **195** prints/hour

Use less space

0.43m²

Compact design and flexible layout



OPTION

Automatic sheet duplex unit

The QSS Green can produce beautiful duplex prints with the optional automatic sheet duplex unit. This enables the production of a wide variety of value-added prints while occupying a small footprint.



Loading the paper is easy

It is easy to print with both roll paper and sheet paper.



Sheet paper

Roll paper

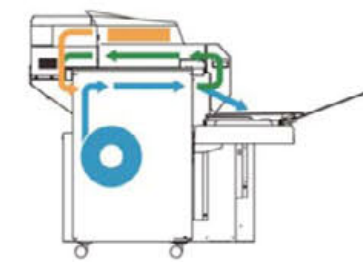

Roll paper
Sheet paper
Duplex print

OPTION

Print sorter

The print sorter automatically sorts the orders to reduce hassle and improve efficiency.



Friendly to the environment and easy ink replacement

There are no photofinishing chemicals involved with dry systems. This means you do not have to worry about maintaining specific temperatures, handling and disposing solution, or any other related troublesome tasks. The QSS Green is friendly to the environment and it is very easy to replace the ink.



Versatile network

Whether you are running a small independent shop or a large professional lab, you can choose a network that meets your needs

Independent shops

EZ Controller used to manage everything from order input to printing. Suitable for shops with limited personnel.



Studios (in-house processing)

For a smooth workflow from photographing the image and then applying corrections to printing it.



Large-scale independent shops/Chain stores

The order taking process is easy, which does wonders to enhance efficiency.



Large-scale chain stores/Labs

Can process large volumes with a scalable network system.

